

Photologic Sensor

OPL530, OPL531, OPL535, OPL536, OPL550, OPL551,
OPL560, OPL561, OPL562, OPL563



Features:

- Choice of four output options in low-cost side-looking package
- Choice of two sensitivity options (OPL560/561/562/563)
- High noise immunity
- Direct TTL/LSTTL CMOS interface
- Data rates to 250 kBaud for all except OPL560 series (200 kBaud)
- Low power consumption

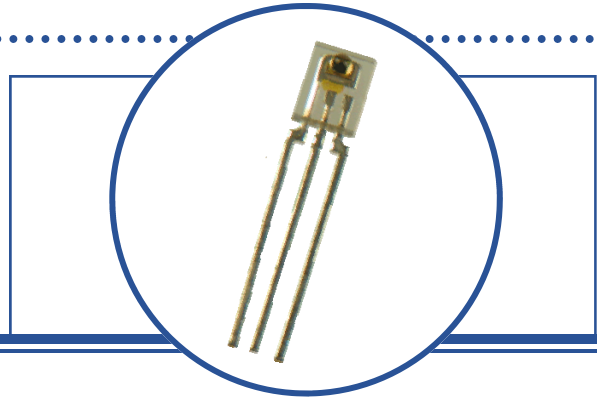

Description:

All components in this series include a photodiode, amplifier, voltage regulator, Schmitt trigger and NPN output transistor on a single silicon chip. **OPL560** chips also include a voltage regulator on the chip. All devices in the series have a Photologic® chip that is encapsulated in a molded plastic side-looking package with an integral lens (recessed integral lens for OPL535 and OPL536). This packaging provides enhanced optical coupling, combined with mechanical protection. The hysteresis characteristics of the Schmitt trigger on each device offers high immunity to noise on input and V_{CC} .

OPL530, OPL531, OPL535 and OPL536 include a 10 K Ω pull-up resistor (R_L) from output to V_{CC} . These components exhibit very stable performance over supply voltages ranging from 4.5 V to 16 V and a wide range of irradiance levels. **OPL550 and OPL551** devices feature TTL/LSTTL compatible logic level output which can drive up to 8 TTL loads without additional circuitry and medium-speed data rates to 250 kBaud, with typical rise and fall times of 25 nanoseconds. **OPL560, OPL561, OPL562 and OPL563** devices feature TTL/LSTTL compatible logic level output which can drive up to 10 TTL loads over supply voltages ranging from 4.5 V to 16 V.

OPL530, OPL531, OPL550, OPL551, OPL560, OPL561, OPL562 and OPL563 are mechanically and spectrally matched to OP140 and OP240 LEDs. **OPL535 and OPL536** are mechanically and spectrally matched to OP145 and OP245 series LEDs.

Applications:

- Non-contact reflective object sensor
- Assembly line automation
- Machine automation
- Machine safety
- End of travel sensor
- Door sensor

Base Part Number	Package	Output Type - with Light	Input Power Range (mW/cm ²) [Min/Max]		
			-	A	B
OPL530	Recessed Lens	Internal 10K - High	0.08/.40	0.08/.25	0.20/0.40
OPL531		Internal 10K - Low			
OPL535		Internal 10K - High			
OPL536		Internal 10K - Low			
OPL550		Totem Pole - High	0.25/2.4	0.25/1.4	
OPL551		Totem Pole - Low	0.25/2.5	0.25/1.5	
OPL560		Totem Pole - High	0.09/.55	0.09/.36	
OPL561		Totem Pole - Low			
OPL562		Totem Pole - High	0.025/.23	0.025/.14	
OPL563		Totem Pole - Low			

OC = Open Collector Output



RoHS

OPTEK reserves the right to make changes at any time in order to improve design and to supply the best product possible.

OPL530, OPL550, OPL560 Series

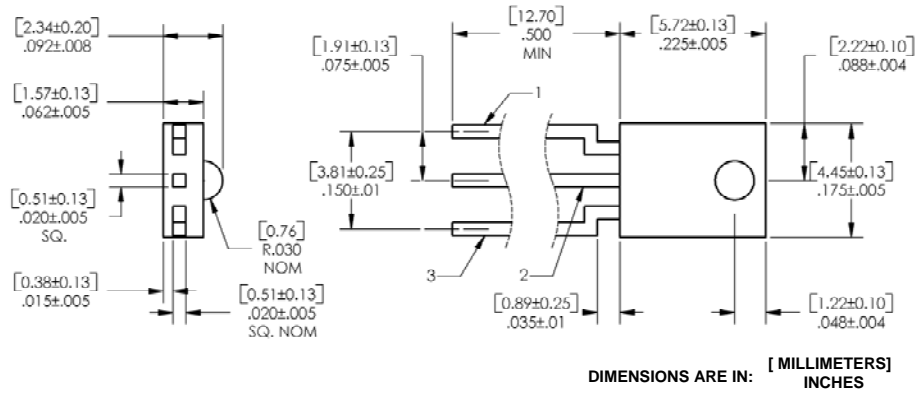

Pin #	Sensor
1	Ground
2	Output
3	V _{CC}

OPL535, OPL536 Series

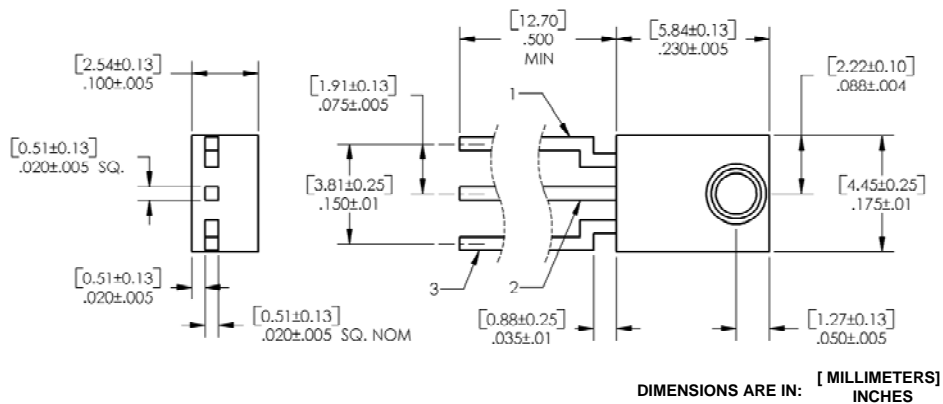

Pin #	Sensor
1	Ground
2	Output
3	V _{CC}

OPTEK reserves the right to make changes at any time in order to improve design and to supply the best product possible.

Photologic Sensor

OPL530, OPL531, OPL535, OPL536, OPL550, OPL551,
OPL560, OPL561, OPL562, OPL563



OPL530, OPL531, OPL535, OPL536, OPL550, OPL551, OPL560, OPL561, OPL562, OPL563 (-OC, -OCA, -OCB)
OPL550, OPL550A, OPL551, OPL551A,
OPL560, OPL560A, OPL561, OPL561A, OPL562, OPL562A, OPL563, OPL563A

OPL550/550A/560/560A/562/562A Totem-Pole

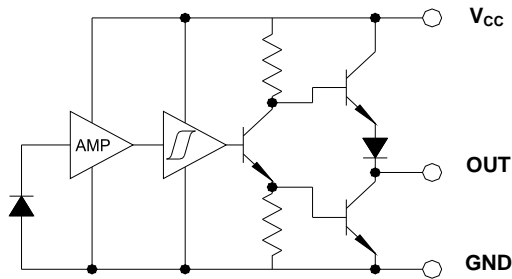

OPL530/535/550/560/562 (-OC, -OCA, -OCB) Open-Collector

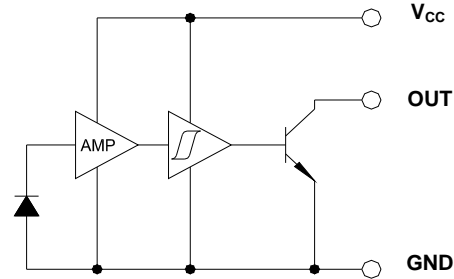

OPL 551/551A/561/561A/563/563A/ Inverted Totem-Pole

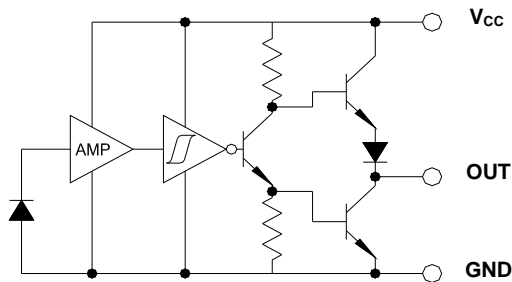

OPL 531/536/551/561/563 (-OC, -OCA, -OCB) Inverted Open-Collector

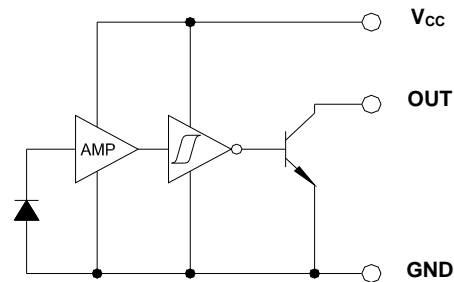

OPL530, OPL530A, OPL530B, OPL531, OPL531A, OPL531B
OPL535, OPL535A, OPL535B, OPL536, OPL536A, OPL536B

OPL530/530A/530B, OPL535/535A/535B 10K Pull-Up

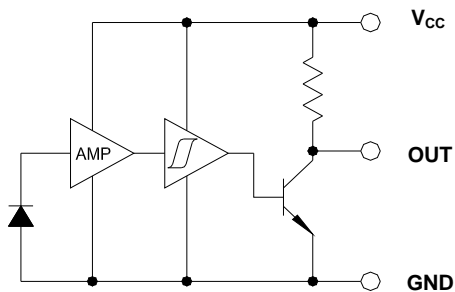

OPL531/531A/531B, OPL536/536A/536B Inverted 10K Pull-Up

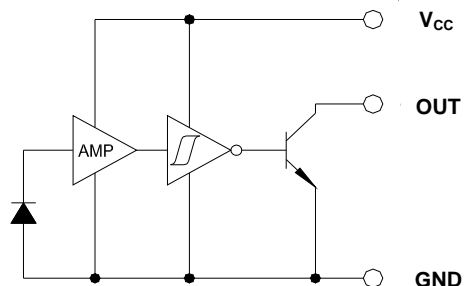
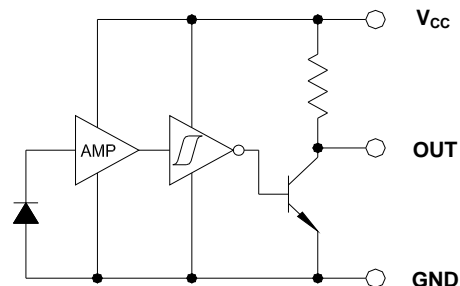
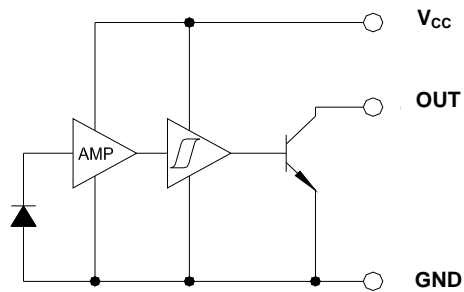

OPTEK reserves the right to make changes at any time in order to improve design and to supply the best product possible.

Absolute Maximum Ratings ($T_A=25^\circ\text{C}$ unless otherwise noted)

Input Diode

Supply Voltage (V_{CC}) OPL530, OPL530-OC, OPL531, OPL531-OC, OPL535, OPL535-OC, OPL536, OPL536-OC, OPL550, OPL551 OPL560, OPL561, OPL562, OPL563	18 V 10 V 18 V
Operating Temperature Range	-40° C to + 85° C
Storage Temperature Range	-40° C to + 100° C
Lead Soldering Temperature [1/16 inch (1.6mm) from the case for 5 sec. with soldering iron]	260°C
Sourcing Current OPL560, OPL561, OPL562, OPL563	10 mA
Power Dissipation OPL530, OPL530-OC, OPL531, OPL531-OC, OPL535, OPL535-OC, OPL536, OPL536-OC OPL550, OPL551, OPL560, OPL561, OPL562, OPL563	90 mW 200 mW ⁽²⁾
Sinking Current OPL530, OPL530-OC, OPL531, OPL531-OC, OPL535, OPL535-OC, OPL536, OPL536-OC OPL550, OPL551 OPL560, OPL561, OPL562, OPL563	50 mA - 50 mA
Voltage at Output Lead ⁽⁴⁾ OPL530, OPL530-OC, OPL531, OPL531-OC, OPL535, OPL535-OC, OPL536, OPL536-OC OPL550-OC, OPL551-OC OPL560-OC, OPL561-OC, OPL562-OC, OPL563-OC	35 V 35 V 35 V
Duration of Output Short to V_{CC} or Ground OP550, OP551	1 second
Duration of Output Short to V_{CC} OPL550-OC, OPL551-OC OPL560, OPL561, OPL562, OPL563, OPL560-OC, OPL561-OC, OPL562-OC, OPL563-OC	1 second 1 second
Low Level Output Current OPL550, OPL551 Series	16 mA
High Level Output Current OPL550, OPL551 Series	1 mA
Irradiance OPL550, OPL551 Series OPL560, OPL560-OC, OPL561, OPL561-OC OPL562, OPL562-OC, OPL563, OPL563-OC	10 mW/cm ² 9 mW/cm ² 3 mW/cm ²

Notes:

- (1) RMA flux is recommended. Duration can be extended to 10 sec. max. when flow soldering. For OPL530, OPL530-OC, OPL531, OPL531-OC, OPL535, OPL535-OC, OPL536 and OPL536-OC, a maximum of 20 grams force may be applied to leads while at soldering temperatures.
- (2) Derate linearly 2.67 mW/°C above 70° C for OPL530, OPL530-OC, OPL531, OPL531-OC, OPL535, OPL535-OC, OPL536 and OPL536-OC. Derate linearly 2.5 mW/°C above 25° C for all devices in the OPL550, OPL551, OPL560, OPL561, OPL562 and OPL563 series.
- (3) Irradiance measurements are made with $\lambda_i = 935$ nm.
- (4) This applies to OC versions only. For I_{CC} on pull-up versions, add $V_{CC}/10$ K Ω .

OPTEK reserves the right to make changes at any time in order to improve design and to supply the best product possible.

Photologic Sensor
OPL530, OPL531, OPL535, OPL536, OPL550, OPL551,
OPL560, OPL561, OPL562, OPL563



Electrical Characteristics ($T_A = 25^\circ\text{C}$ unless otherwise noted)

SYMBOL	PARAMETER	MIN	TYP	MAX	UNITS	TEST CONDITIONS
V_{CC}	Operating Supply Voltage OPL530, OPL530-OC, OPL531, OPL531-OC OPL535, OPL535-OC, OPL536, OPL536-OC, OPL560, OPL561 Series	4.5	-	16	V	-
	OPL550, OPL551 Series	4.5	-	5.5	V	-
	Peak-to-Peak V_{CC} Ripple Necessary to Cause False Triggering of Output OPL530, OPL530-OC, OPL531, OPL531-OC OPL535, OPL535-OC, OPL536, OPL536-OC OPL560, OPL561 Series	-	-	2	V	f = DC to 50 MHz
	OPL550, OPL551 Series	-	2	-	V	$V_{CC} = 5\text{ V DC}$, f = DC to 50 MHz
I_{CC}	Supply Current ⁽⁴⁾ OPL530, OPL530-OC, OPL531, OPL531-OC OPL535, OPL535-OC, OPL536, OPL536-OC	-	2.7	5	mA	$E_E = 0$ or 1 mW/cm^2
	OPL550, OPL551 Series	-	8	15	mA	$E_E = 0$ or 3 mW/cm^2 , $V_{CC} = 5.5\text{ V}$
	OPL560, OPL561 Series	-	8	12	mA	$E_E = 0$ or 1 mW/cm^2
$E_{eT(+)}$	Positive-Going Threshold Irradiance ⁽³⁾ OPL530, OPL530-OC, OPL531, OPL531-OC OPL535, OPL535-OC, OPL536, OPL536-OC	0.08	-	0.40	mW/cm^2	$T_A = 25^\circ\text{C}$
	OPL530A, OPL530-OCA, OPL531A, OPL531-OCA OPL535A, OPL535-OCA, OPL536A, OPL536-OCA	0.08	-	0.25	mW/cm^2	$T_A = 25^\circ\text{C}$
	OPL530B, OPL530-OCB, OPL531B, OPL531-OCB OPL535B, OPL535-OCB, OPL536B, OPL536-OCB	0.12	-	0.40	mW/cm^2	$T_A = 25^\circ\text{C}$
	OPL550, OPL550-OC, OPL551, OPL551-OC OPL550A, OPL550-OCA, OPL551, OPL551-OCA	.25 .25	- -	2.4 1.4	mW/cm^2 mW/cm^2	$V_{CC} = 5\text{ V}$, $T_A = 25^\circ\text{C}$ $V_{CC} = 5\text{ V}$, $T_A = 25^\circ\text{C}$
$E_{eT(+)} / E_{eT(-)}$	Hysteresis Ratio OP530, OP531 Series	1.05	1.3	1.6	-	-
	OP535, OP536 Series	1.05	1.2	1.5	-	-
	OPL550, OPL551 Series	1.50	2	2.5	-	-
	OPL560, OPL561 Series	1.20	1.55	2	-	-
$\Delta E_{et(+)} (\Delta T)$	Temperature Co-efficient OPL530, OPL530-OC, OPL531, OPL531-OC	-	-0.6	-	%/ $^\circ\text{C}$	$>0^\circ\text{C}$
	OPL535, OPL535-OC, OPL536, OPL536-OC	-	-1.6	-	%/ $^\circ\text{C}$	$<0^\circ\text{C}$

Notes:

- (1) RMA flux is recommended. Duration can be extended to 10 sec. max. when flow soldering. For OPL530, OPL530-OC, OPL531, OPL531-OC, OPL535, OPL535-OC, OPL536 and OPL536-OC, a maximum of 20 grams force may be applied to leads while at soldering temperatures.
- (2) Derate linearly 2.67 $\text{mW}/^\circ\text{C}$ above 70°C for OPL530, OPL530-OC, OPL531, OPL531-OC, OPL535, OPL535-OC, OPL536 and OPL536-OC. Derate linearly 2.5 $\text{mW}/^\circ\text{C}$ above 25°C for all devices in the OPL550, OPL551, OPL560, OPL561, OPL562 and OPL563 series.
- (3) Irradiance measurements are made with $\lambda_i = 935\text{ nm}$.
- (4) This applies to OC versions only. For I_{CC} on pull-up versions, add $V_{CC}/10\text{ K}\Omega$.

OPTEK reserves the right to make changes at any time in order to improve design and to supply the best product possible.

Electrical Characteristics ($T_A = 25^\circ\text{C}$ unless otherwise noted)

SYMBOL	PARAMETER	MIN	TYP	MAX	UNITS	TEST CONDITIONS
V_{OH}	Operating Supply Voltage OPL550	2.4	3.3	-	V	$V_{CC} = 4.5\text{ V}$, $I_{OH} = -800\ \mu\text{A}$, $E_E = 3\text{ mW/cm}^2$
	OPL551	2.4	3.3	-	V	$V_{CC} = 4.5\text{ V}$, $I_{OH} = -800\ \mu\text{A}$, $E_E = 0$
	OPL560	$V_{CC} - 2.1$	-	-	V	$I_{OH} = -1\ \mu\text{A}$, $E_E = 1\text{ mW/cm}^2$
	OPL561	$V_{CC} - 2.1$	-	-	V	$I_{OH} = -1\ \mu\text{A}$, $E_E = 0$
V_{OL}	Low Level Output Voltage OPL530, OPL530-OC, OPL535, OPL535-OC	-	0.2	0.4	V	$I_{OL} = 16\text{ mA}$, $E_E = 0$
	OPL531, OPL531-OC, OPL536, OPL536-OC	-	0.2	0.4	V	$I_{OL} = 16\text{ mA}$, $E_E = 1\text{ mW/cm}^2$
	OPL550	-	0.25	0.4	V	$V_{CC} = 4.5\text{ V}$, $I_{OL} = 12.8\text{ mA}$, $E_E = 0$
	OPL551	-	0.25	0.4	V	$V_{CC} = 4.5\text{ V}$, $I_{OL} = 12.8\text{ mA}$, $E_E = 3\text{ mW/cm}^2$
	OPL560, OPL560-OC	-	-	.4	V	$I_{OL} = 16\text{ mA}$, $E_E = 0$
	OPL561, OPL561-OC	-	-	.4	V	$I_{OL} = 16\text{ mA}$, $E_E = 1\text{ mW/cm}^2$
I_{OS}	Short Circuit Output Current OPL550	-20	-55	-100	mA	$V_{CC} = 5.5\text{ V}$, Output = GND, $E_E = 3\text{ mW/cm}^2$
	OPL551	-20	-55	-100	mA	$V_{CC} = 5.5\text{ V}$, Output = GND, $E_E = 0$
I_{OH}	High Level Output Current ⁽⁴⁾ OPL531, OPL531-OC, OPL536, OPL536-OC	-	0.1	10	μA	$V_{OH} = 30\text{ V}$, $E_E = 0$
	OPL535, OPL535-OC, OPL530, OPL530-OC	-	0.1	10	μA	$V_{OH} = 30\text{ V}$, $E_E = 1\text{ mW/cm}^2$
	OPL550-OC	-	1	100	μA	$V_{CC} = 4.5\text{ V}$, $V_{OH} = 30\text{ V}$, $E_E = 3\text{ mW/cm}^2$
	OPL551-OC	-	1	100	μA	$V_{CC} = 4.5\text{ V}$, $V_{OH} = 30\text{ V}$, $E_E = 0$
	OPL560-OC	-	-	100	μA	$V_{OH} = 30\text{ V}$, $E_E = 1\text{ mW/cm}^2$
	OPL561-OC	-	-	100	μA	$V_{OH} = 30\text{ V}$, $E_E = 0$

Notes:

- (1) RMA flux is recommended. Duration can be extended to 10 sec. max. when flow soldering. For OPL530, OPL530-OC, OPL531, OPL531-OC, OPL535, OPL535-OC, OPL536 and OPL536-OC, a maximum of 20 grams force may be applied to leads while at soldering temperatures.
- (2) Derate linearly 2.67 mW/ $^\circ\text{C}$ above 70 $^\circ\text{C}$ for OPL530, OPL530-OC, OPL531, OPL531-OC, OPL535, OPL535-OC, OPL536 and OPL536-OC. Derate linearly 2.5 mW/ $^\circ\text{C}$ above 25 $^\circ\text{C}$ for all devices in the OPL550, OPL551, OPL560, OPL561, OPL562 and OPL563 series.
- (3) Irradiance measurements are made with $\lambda_i = 935\text{ nm}$.
- (4) This applies to OC versions only. For I_{CC} on pull-up versions, add $V_{CC}/10\text{ K}\Omega$.

OPTEK reserves the right to make changes at any time in order to improve design and to supply the best product possible.

Photologic Sensor
OPL530, OPL531, OPL535, OPL536, OPL550, OPL551,
OPL560, OPL561, OPL562, OPL563



Electrical Characteristics ($T_A = 25^\circ\text{C}$ unless otherwise noted)

SYMBOL	PARAMETER	MIN	TYP	MAX	UNITS	TEST CONDITIONS
t_r	Output Rise Time OPL530, OPL531, OPL535, OPL536	-	1.5	-	μs	$E_E = 0$ or 1 mW/cm^2 , $C_L = 50 \text{ pF}$
	OPL530-OC, OPL531-OC, OPL535-OC, OPL536-OC	-	50	-	ns	$E_E = 0$ or 1 mW/cm^2 , $R_L = 300 \Omega$ to 5 V , $C_L = 50 \text{ pF}$
	OPL550, OPL551	-	25	70	ns	$V_{CC} = 5 \text{ V}$, $T_A = 25^\circ\text{C}$, $E_E = 0$ or 3 mW/cm^2 , $f = 10 \text{ kHz}$, DC = 50% $R_L = 8 \text{ TTL loads}$
	OPL550-OC, OPL551-OC	-	25	70	ns	$V_{CC} = 5 \text{ V}$, $T_A = 25^\circ\text{C}$, $E_E = 0$ or 3 mW/cm^2 , $f = 10 \text{ kHz}$, DC = 50%, $R_L = 360 \Omega$
	OPL560, OPL561	-	-	70	ns	$T_A = 25^\circ\text{C}$, $E_E = 0$ or 1 mW/cm^2 , $f = 10 \text{ kHz}$, DC = 50%,
	OPL560-OC, OPL561-OC	-	-	100	μs	$R_L = 360 \Omega$
t_r	Output Rise Time OPL530, OPL531, OPL535, OPL536	-	-	-	μs	$E_E = 0$ or 1 mW/cm^2 , $C_L = 50 \text{ pF}$
	OPL530-OC, OPL531-OC, OPL535-OC, OPL536-OC	-	-	-	ns	$E_E = 0$ or 1 mW/cm^2 , $R_L = 300 \Omega$ to 5 V , $C_L = 50 \text{ pF}$
	OPL550-OC, OPL551-OC	-	25	70	ns	$V_{CC} = 5 \text{ V}$, $T_A = 25^\circ\text{C}$, $E_E = 0$ or 3 mW/cm^2 , $R_L = 8 \text{ TTL loads}$, $f = 10 \text{ kHz}$, DC = 50%
	OPL560-OC, OPL561-OC	-	-	70	ns	$V_{CC} = 5 \text{ V}$, $T_A = 25^\circ\text{C}$, $E_E = 0$ or 3 mW/cm^2 , $R_L = 8 \text{ TTL loads}$, $f = 10 \text{ kHz}$, DC = 50%
	OPL560, OPL561	-	-	70	ns	$T_A = 25^\circ\text{C}$, $E_E = 0$ or 1 mW/cm^2 , $f = 10 \text{ kHz}$
	OPL560-OC, OPL561-OC	-	-	100	ns	$T_A = 25^\circ\text{C}$, $E_E = 0$ or 1 mW/cm^2 , $f = 10 \text{ kHz}$
t_f	Output Fall Time OPL530, OPL531, OPL535, OPL536	-	20	-	ns	$E_E = 0$ or 1 mW/cm^2 , $C_L = 50 \text{ pF}$
	OPL530-OC, OPL531-OC, OPL535-OC, OPL536-OC	-	20	-	ns	$E_E = 0$ or 1 mW/cm^2 , $R_L = 300 \Omega$ to 5 V , $C_L = 50 \text{ pF}$
	OPL550-OC, OPL551-OC	-	25	70	ns	$V_{CC} = 5 \text{ V}$, $T_A = 25^\circ\text{C}$, $E_E = 0$ or 3 mW/cm^2 , $R_L = 360 \Omega$, $f = 10 \text{ kHz}$, DC = 50%
	OPL560, OPL561	-	-	70	ns	$T_A = 25^\circ\text{C}$, $E_E = 0$ or 1 mW/cm^2 , $f = 10 \text{ kHz}$
	OPL560-OC, OPL561-OC	-	-	100	ns	$T_A = 25^\circ\text{C}$, $E_E = 0$ or 1 mW/cm^2 , $f = 10 \text{ kHz}$

Notes:

- (1) RMA flux is recommended. Duration can be extended to 10 sec. max. when flow soldering. For OPL530, OPL530-OC, OPL531, OPL531-OC, OPL535, OPL535-OC, OPL536 and OPL536-OC, a maximum of 20 grams force may be applied to leads while at soldering temperatures.
- (2) Derate linearly $2.67 \text{ mW}/^\circ\text{C}$ above 70°C for OPL530, OPL530-OC, OPL531, OPL531-OC, OPL535, OPL535-OC, OPL536 and OPL536-OC. Derate linearly $2.5 \text{ mW}/^\circ\text{C}$ above 25°C for all devices in the OPL550, OPL551, OPL560, OPL561, OPL562 and OPL563 series.
- (3) Irradiance measurements are made with $\lambda_i = 935 \text{ nm}$.
- (4) This applies to OC versions only. For I_{CC} on pull-up versions, add $V_{CC}/10 \text{ K}\Omega$.

OPTEK reserves the right to make changes at any time in order to improve design and to supply the best product possible.

Electrical Characteristics ($T_A = 25^\circ\text{C}$ unless otherwise noted)

SYMBOL	PARAMETER	MIN	TYP	MAX	UNITS	TEST CONDITIONS
tpE _{er} (+)	Propagation Delay OPL530, OPL531, OPL535, OPL536	-	1.0	-	μs	E _E = 0 or 1 mW/cm ² , R _L = 300 Ω to 5 V, C _L = 50 pF
	OPL530-OC, OPL531-OC, OPL535-OC, OPL536-OC	-	1.0	-	μs	E _E = 0 or 1 mW/cm ² , R _L = 300 Ω to 5 V, C _L = 50 pF
	OPL550-OC, OPL551-OC	-	2.5	5	μs	V _{CC} = 5 V, T _A = 25° C, E _E = 0 or 3 mW/cm ² , R _L = 8 TTL loads, f = 10 kHz, DC = 50%
tpE _{er} (-)	Propagation Delay OPL530, OPL531, OPL535, OPL536, OPL530-OC, OPL531-OC, OPL535-OC, OPL536-OC	-	3.0	-	μs	E _E = 0 or 1 mW/cm ² , R _L = 300 Ω to 5V, C _L = 50 pF
	OPL550-OC, OPL551-OC	-	2.5	5	μs	V _{CC} = 5 V, T _A = 25° C, E _E = 0 or 3 mW/cm ² , R _L = 360 Ω, f = 10 kHz, DC = 50%
t _{PLH} , T _{PHL}	Propagation Delay (Low-High/High-Low) OPL560, OPL561	-	5	-	μs	DC = 50%, R _L = 10 TTL Loads
	OP560-OC, OPL561-OC	-	5	-	μs	DC = 50%, R _L = 300 Ω

Notes:

- (1) RMA flux is recommended. Duration can be extended to 10 sec. max. when flow soldering. For OPL530, OPL530-OC, OPL531, OPL531-OC, OPL535, OPL535-OC, OPL536 and OPL536-OC, a maximum of 20 grams force may be applied to leads while at soldering temperatures.
- (2) Derate linearly 2.67 mW/°C above 70° C for OPL530, OPL530-OC, OPL531, OPL531-OC, OPL535, OPL535-OC, OPL536 and OPL536-OC. Derate linearly 2.5 mW/° C above 25° C for all devices in the OPL550, OPL551, OPL560, OPL561, OPL562 and OPL563 series.
- (3) Irradiance measurements are made with λ_i = 935 nm.
- (4) This applies to OC versions only. For I_{CC} on pull-up versions, add V_{CC}/10 KΩ.

OPTEK reserves the right to make changes at any time in order to improve design and to supply the best product possible.